

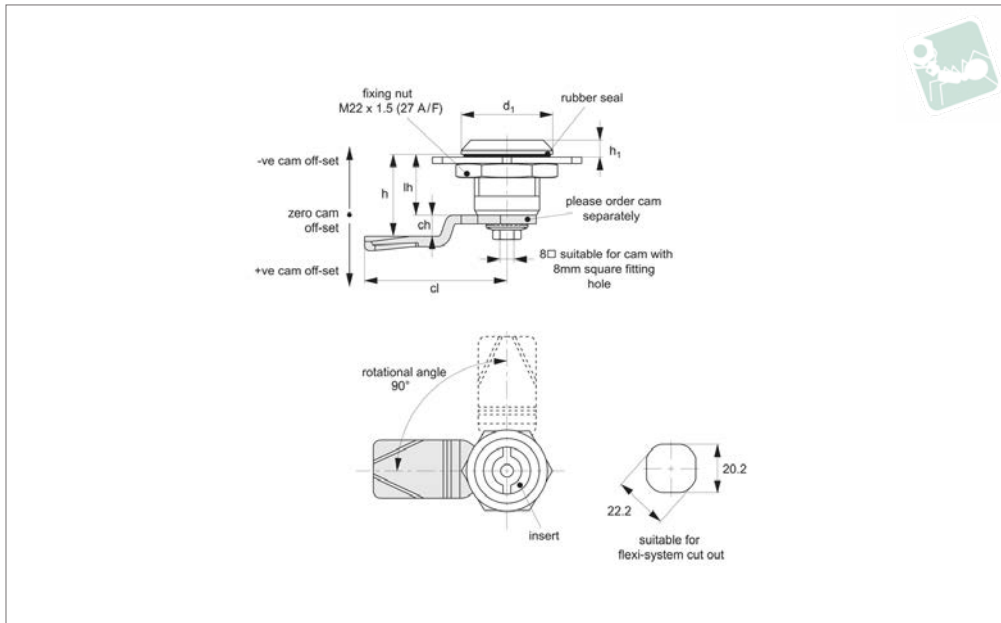

Cam Latches - Flexi-System

insert driver - fixed grip - plastic

Latches



CC0410

LATCHES

Material

Body: polyamide plastic, black.
 Insert: zinc alloy, black coated. Fitted with O'ring to achieve IP54 rating. Internal spring provides 1,5mm torsion.
Supplied with: Nut: steel, zinc plated.
 Sealing washer: PU & Rubber.
Not supplied: CAM nor KEY - order separately.

Technical Notes

Order cam and key separately.

Cams: see suitable cam CC0020, and CC0040. Select „without projection“ cam type.

Dimensions ch and cl relate to cam. Use formula to calculate ch (required cam off-set), and refer to cam selection chart;

ch = h - lh where;

ch = required cam off-set/height.

h = grip length (distance between inside of latch face and front of cam).

lh = body length of cam latch/lock to be

used (see product table below).

Keys: see CC0010.

Rods & Guides: to achieve 3-point latching - CC0340, CC0350, CC0355.

Important Notes







An inexpensive alternative to stainless steel, where water or other solutions may cause corrosion.

Sold subject to pack quantity.

| Order No. | Insert driver | d ₁ | h ₁ | lh |
|--------------|----------------|----------------|----------------|----|
| CC0410.M0010 | Square 7 | 28 | 6 | 18 |
| CC0410.M0020 | Square 8 | 28 | 6 | 18 |
| CC0410.M0040 | Triangle 7 | 28 | 6 | 18 |
| CC0410.M0050 | Triangle 8 | 28 | 6 | 18 |
| CC0410.M0060 | 3mm Double Bit | 28 | 6 | 18 |
| CC0410.M0070 | 4mm Double Bit | 28 | 6 | 18 |
| CC0410.M0080 | Slotted (2x4) | 28 | 6 | 18 |



Available insert drivers:

| Square 7 | Square 8 | Triangle 7 | Triangle 8 | 3mm Double Bit | 4mm Double Bit | 2 x 4mm Slotted |
|--|---|---|---|---|---|---|
|  |  |  |  |  |  |  |