

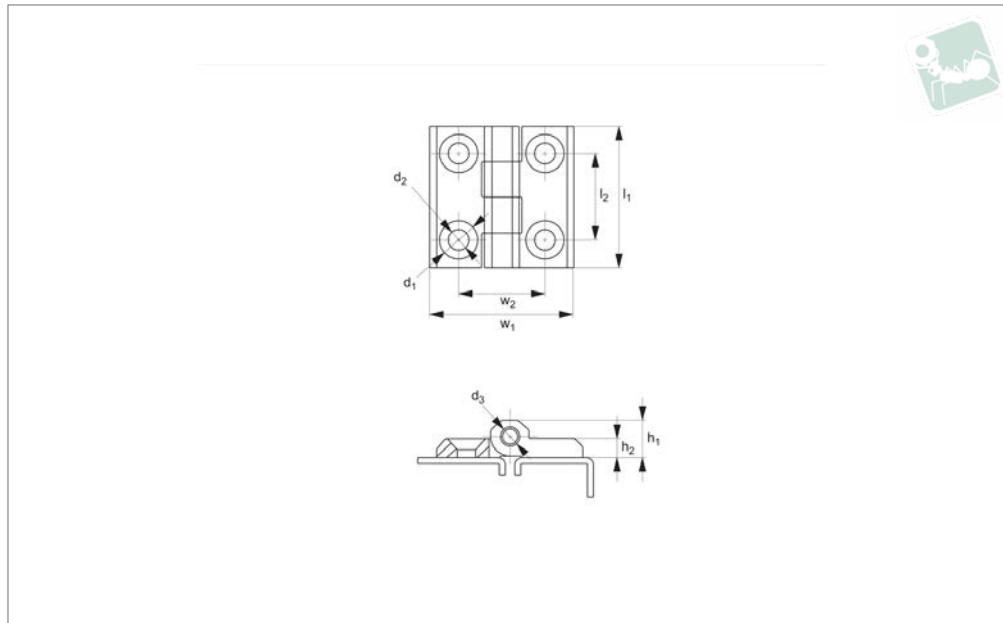

Surface Mount - Leaf Hinges

screw mount - stainless steel

Stays & Hinges



HH0020

STAYS & HINGES

Material

Stainless steel, AISI 304.

electrical panels and covers.

Opening angle 180°.

Technical Notes

For plain/flush mounted doors, as well as

Order No.	Size	h_1	h_2	l_1	l_2	w_1	w_2	d_1	d_2	d_3	90° Angled stress kN	Axial load F_x N max.	Axial stress kN	Radial load F_x N max.	Radial stress kN
HH0020.M0050	50 x 50	11,5	6	50	30	50	30	12,5	6,3	7	2,45	1,3	2,10	1,2	3,5
HH0020.M0060	60 x 60	15,0	8	60	36	60	36	12,5	8,4	8	4,40	1,8	3,20	1,5	6,0

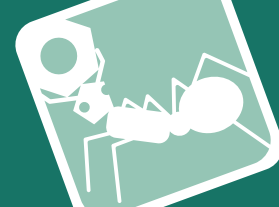

Concealed hinges

For added security or a sleek enclosure design, concealed hinges offer the solution with mounting discreetly hidden away from view to avoid tampering.

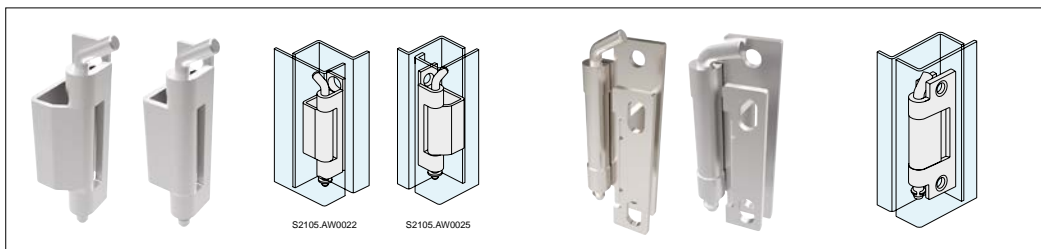

Concealed pivot hinges

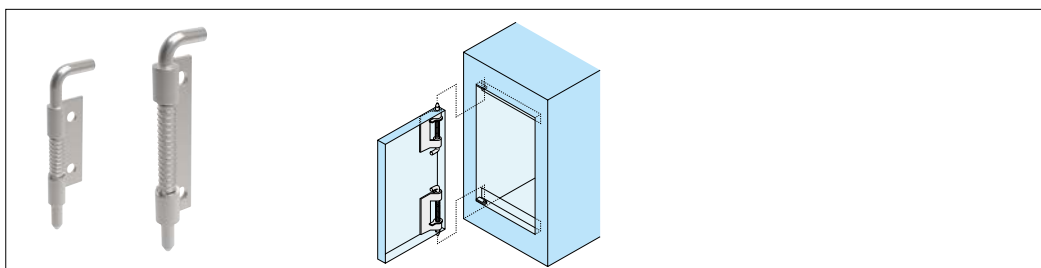

End mount concealed pivot hinges

Door removal hinges

Door removal or lift-off hinges simplify removal of covers and panels to ease access for maintenance and repair, available in a selection of materials.

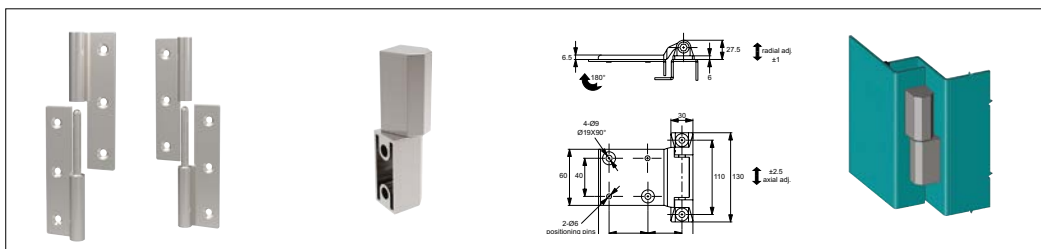

Lift off hinges

Torque and positioning hinges

Torque and positioning hinges offer positive location of panels, screens and displays using constant friction for a firm hold.



Constant torque hinges

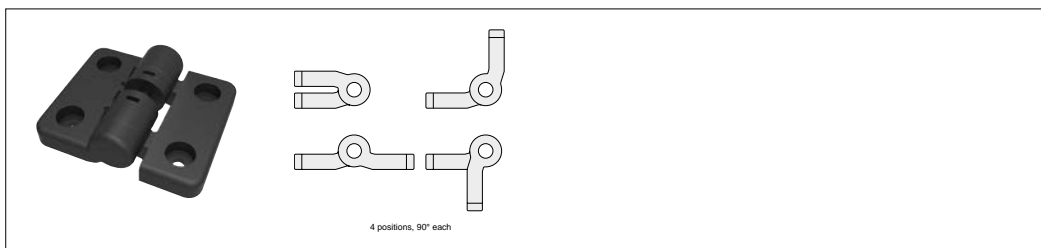

Detent positioning hinges



Wixroyd have a diverse range of hinges to suit most industrial applications in a wide range of materials and finishes.

Throughout our catalogue we refer to parts as being of a "Left" or "Right" type or hand. Which type you need, is most easily explained as follows;

Oriente your application so that when opened the door/panel comes towards you. With this orientation in mind, look to see on which side of the door/panel the hinges are mounted?

If the hinges are on the left side of the door/panel then you require "Left" type products. If the hinges are on the right side of the door/panel then you require "Right" type products.

The illustration on the right clearly indicates the layout and orientation of the door where a "left" or "right" product is used.

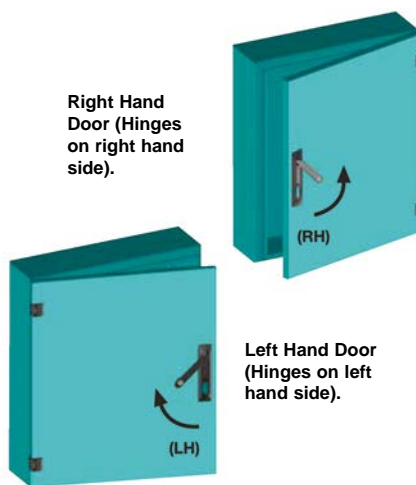

**Left or right type:
Which do you need?**

STAYS & HINGES

Hinges

External or surface mount hinges have a wide range of application on electrical panels, sheet metal enclosures, generators and heating and venting applications.

External hinges

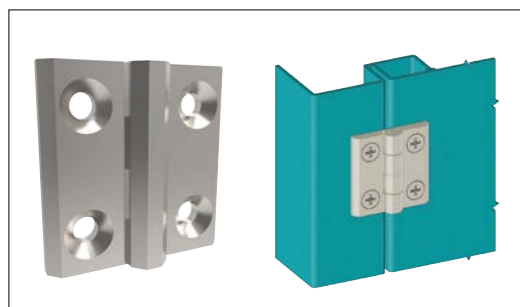

Surface mount hinges

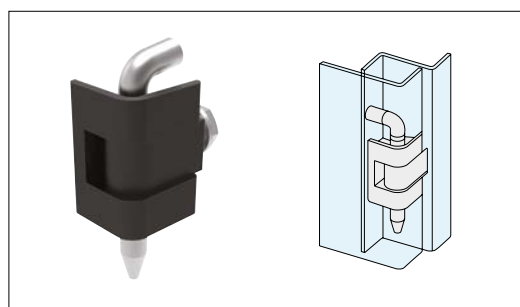

Corner hinges

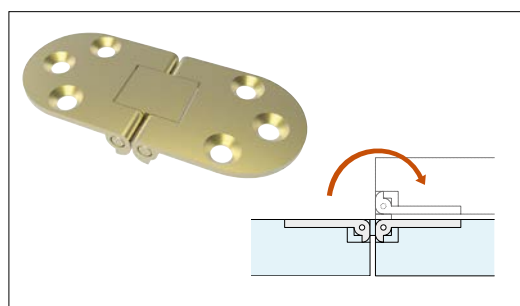

Flush mount hinges

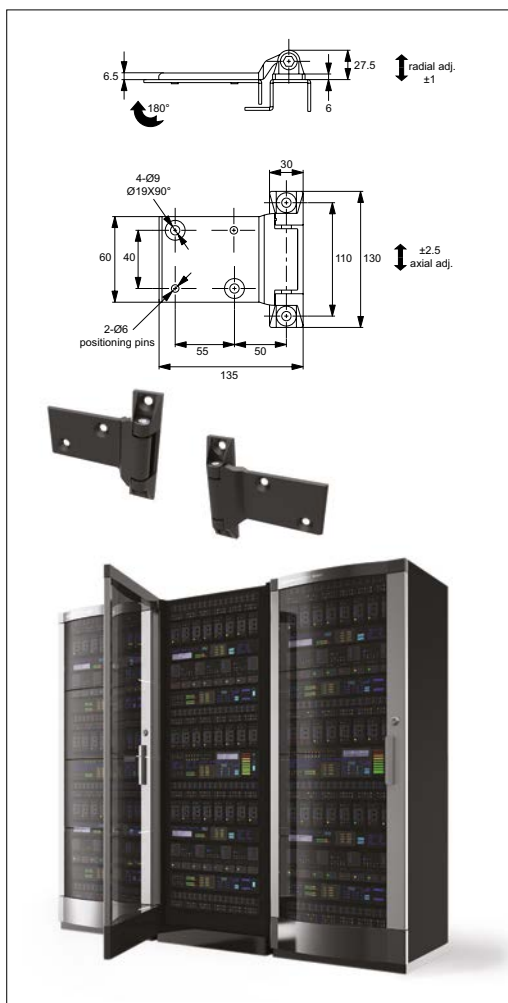

Surface mount hinges

ov-WS0050-A-T-WS2300-A-THH1200-wide-range-of-solutions-b-rnh - Updated - 01-11-2022